

Forbice SUPER STAR SF CE - Cod. FOPN.0900

CAMPAGNOLA S.r.l - Tav.: 0350.0481 Release / Versione 01

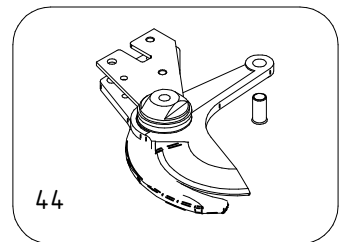
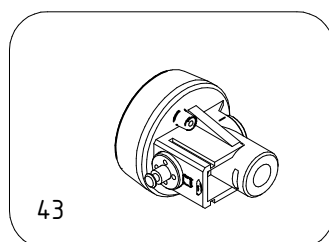
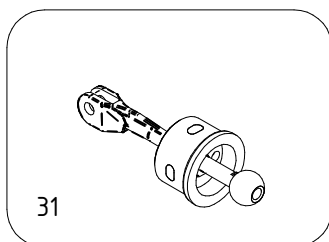
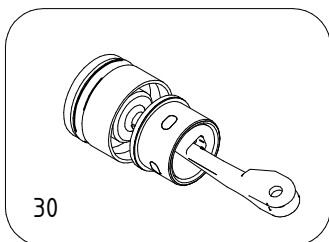
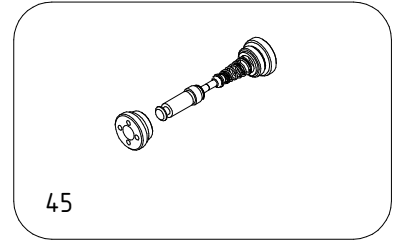
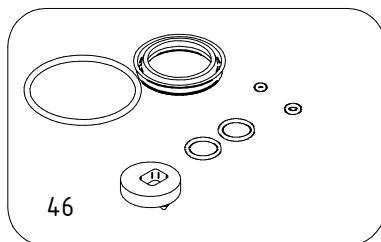
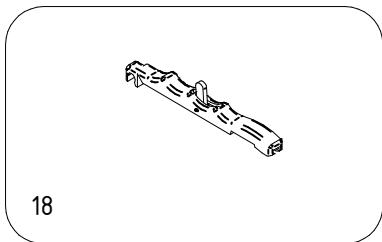
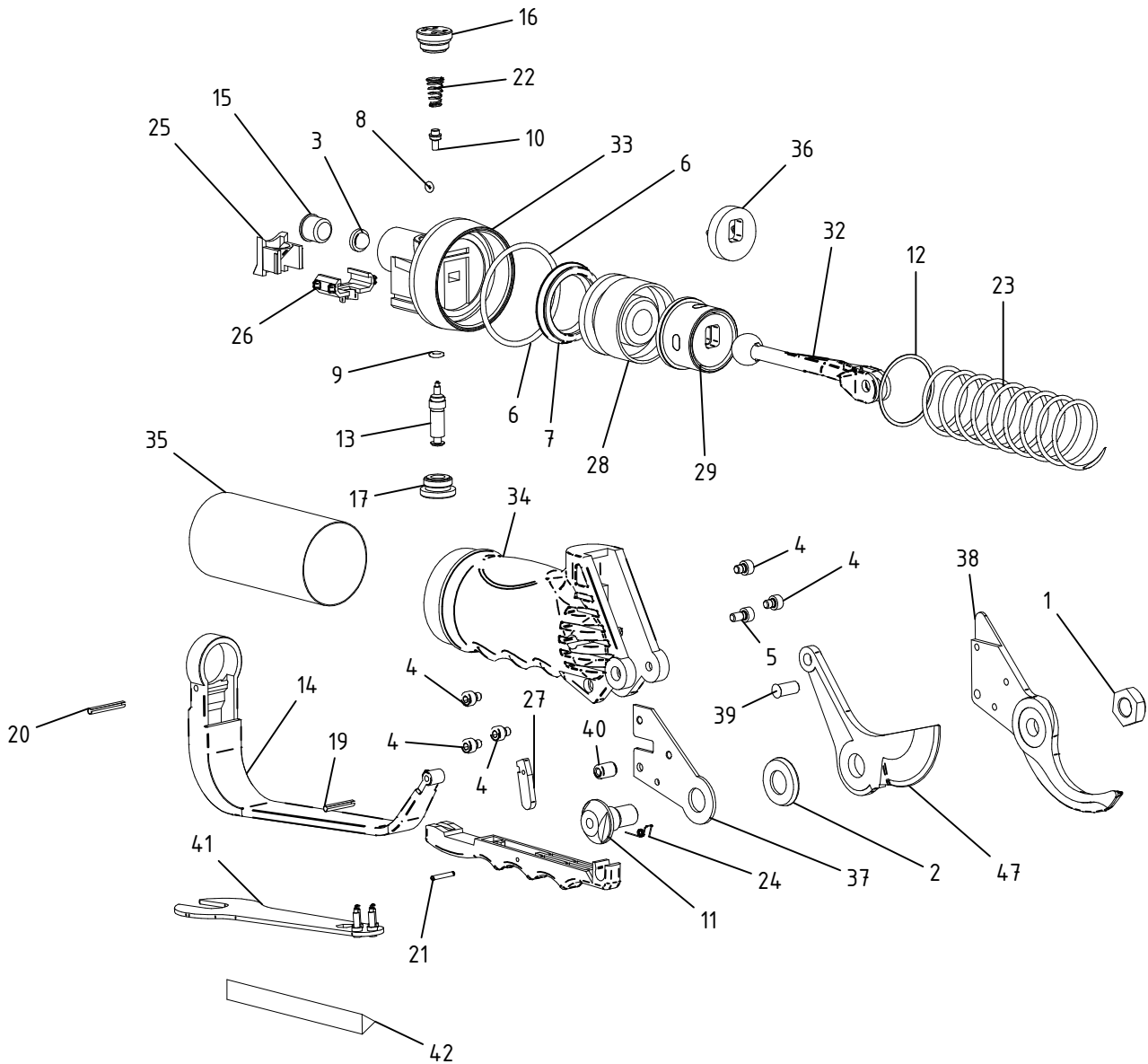

Zum Bestellen bitte die gewünschte Bildnummer ankreuzen und die benötigte Stückzahl dazuschreiben.
Einsenden per E-Mail an lager@schmidt-ermstedt.de oder als Foto per WhatsApp an +493620877563